



KEY FEATURES

- Powered two-way point source
- 12" woofer, 1.4" HF compression driver
- 96kHz / 40 bit floating point CORE processing with PRONET remote control
- Digitally controlled Class D amplifier module with SMPS
- Asymmetric HF coverage pattern
- Rotatable HF horn
- Non-symmetrical, multi-angled enclosure
- M10 rigging points
- Pole mount socket

APPLICATIONS

- Theatre underbalcony
- Corporate and A/V
- TV and broadcast
- Stage monitoring
- Live music venues
- Bars and restaurants
- House of Worship

TECHNICAL SPECIFICATIONS

SYSTEM

System's Acoustic Principle	Two-way Vented Enclosure Asymmetric Dispersion
Frequency Response (-6dB)	65 Hz – 17 kHz (processed)
Horizontal/ Vertical Coverage Angle	60° to 100° asymmetric, (-6dB) / 60° av, 1kHz to 20kHz (-6dB)
Maximum (peak) Output	132 dB SPL @ 1m

TRANSDUCERS

LF	One 12" (305mm) LF driver, 3" (76mm) aluminium voice coil
HF	One 1.4" (35.5mm) HF compression driver, 2.4" (61mm) aluminium voice coil

ELECTRICAL

Input Impedance	20 kΩ balanced, 10 kΩ unbalanced
Input Sensitivity	+4dBu / 1.25 V
Signal Processing	CORE processing, 96kHz / 40bit floating point SHARC DSP, 24 bit AD/DA converters
Direct access Controls	4 Presets (STANDARD/LOW CUT/MONITOR/USER), Network Termination, GND Link
Remote Control	PRONET control software
Network Protocol	CANBUS
Amplifier Type	Class D with SMPS
Output Power	900W + 300W
Mains Voltage Range (Vac)	230V ±15% - 115 ±15% 50/60Hz (internally selectable)
IN / OUT Connectors	Neutrik XLR-M / XLR-F
IN / OUT Network Connectors	ETHERCON®(NE8FAV)
Mains Input / Link Connector	PowerCon® (NAC3MPA), PowerCon® (NAC3MPB)
Cooling	Variable speed DC fan

ENCLOSURE & CONSTRUCTION

Dimensions (W x H x D)	360 mm (14.2") x 610 mm (24") x 310 mm (12.2")
Taper	Stage Monitor: 35° - Frontfill: 7.5°
Enclosure Material	15mm, reinforced phenolic birch
Paint	High resistance, black water based paint
Flying System	M10 flying points or dedicated metal bracket
Net Weight	19kg (41.8 lbs)



DESCRIPTION

The ED120A is a two-way powered point source loudspeaker that provides full frequency response and controlled dispersion from an easily manageable enclosure. It is designed for many kinds of foreground sound reinforcement applications requiring high quality sound, repeatable performance, and convenience of operation in an easily portable format.

The 12" low frequency driver is matched to a 1.4" high frequency compression driver, both components using aluminium voice coils for low weight and good transient response and being driven by individual channels of a powerful Class D amplifier module.

The ED120A's non-symmetrical vented enclosure allows it to adapt to multiple portable and fixed applications, such as front-of-house duties on a speaker stand, or pole mounted on an associated subwoofer or, by using the 35° wedge angle, as a powerful stage monitor.

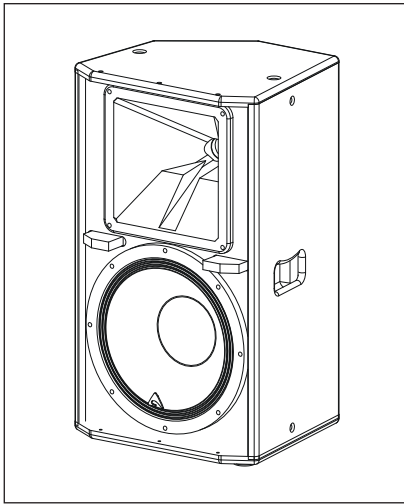

A key feature of the ED120A is its asymmetrical high frequency coverage pattern, varying from 100° horizontal in the lower part of the horn for more effective near field coverage, and narrowing to 60° horizontal at the top of the horn for more focused coverage in the far field. The result is more accurate coverage of a typical auditorium than is possible with a fixed horizontal coverage device. The HF horn is also rotatable through 90° by simply removing four screws and re-aligning the horn, so that in a stage monitor mode the asymmetrical pattern optimises coverage for performers both near to, and further away from, the monitor. This rotatable horn feature also makes it possible to maintain the ideal coverage pattern when the cabinet is installed in a horizontal (landscape) format.

The 15mm phenolic birch plywood cabinet is provided with a 35mm pole mount, a recessed handle for easy lifting and handling, and M10 rigging points to allow suspension in fixed installations using optional mounting brackets.

To extend the system's low frequency response the ED120A can be complemented by subwoofers from the Axiom SW series such as the SW18A.

SYSTEM PROCESSING

The system processing is based on the CORE DSP platform designed by the PROEL R&D Laboratories using one of the most advanced SHARC DSP for audio application. It features 40bit, 96kHz floating point resolution and top quality 24bit AD/DA converters for perfect signal integrity, dynamic range in excess of 110dB, and superior sonic performance. Thanks to its massive processing power, the CORE platform is capable of providing the most sophisticated algorithms for speaker processing, together with remote control and networking capability.

The CORE DSP makes it possible to set an optimal TIME ALIGNMENT for the crossover filter resulting in a linear phase response. The correct acoustic filtering has been achieved using the Constant Power Crossover technique that, thanks to a particular phase relation, results in a very smooth transition between LF and HF and an even dispersion in the crossover region.

The PRONET control software, working on a solid and reliable CANBUS based network protocol, provides an intuitive interface for the remote control of the whole system, with the possibility of EQing, delaying, managing the protection functions, and monitoring the status of the amplifier.

POWER AMPLIFIER

The ED120A is powered by a DA SERIES digital power module, a new generation of CLASS D power amplifier with SMPS. The innovative technology used for these amplifiers offers top-of-the-range performances, such as a superior sound definition at any audio frequency, very high dynamics even for low level signals, and very low distortion even at maximum power.

The superior sound quality can be compared with top-of-the-range AB-class analog systems, while the DA module features higher dynamic range, very compact size, light weight, and efficiency above 90%.

Output power is optimised specifically to the drive units for efficient power transfer, with the low frequency section producing 900

watts while 300 watts is available for the high frequency compression driver. Input and link connections are via balanced 3-pin XLR connectors, and a ground lift switch is provided for hum-free operation. Mains power is connected through a locking Neutrik PowerCON, and a Power Out connector allows mains power to be linked to additional ED120A cabinets.

MOUNTING AND FIXING

The ED120A can be wall mounted in permanent installations either vertically or horizontally using the KPTED120B wall bracket. The wall bracket allows five steps of incremental rotational adjustment to enable the loudspeaker to be accurately aimed. When mounted horizontally the loudspeaker's asymmetrical HF waveguide can be rotated through 90° within the enclosure to maintain the optimum coverage pattern.

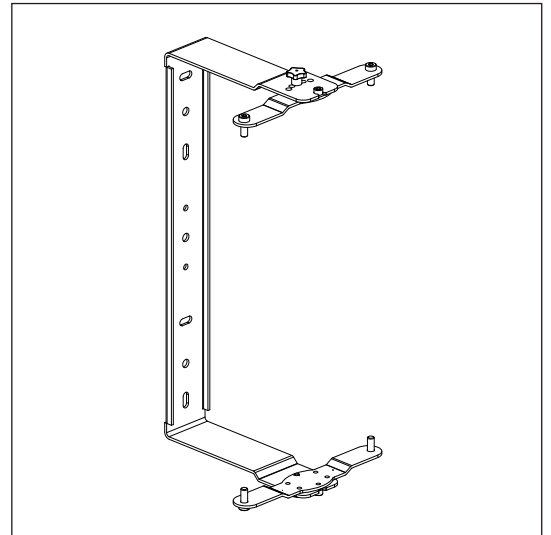

ENGINEERING DRAWING

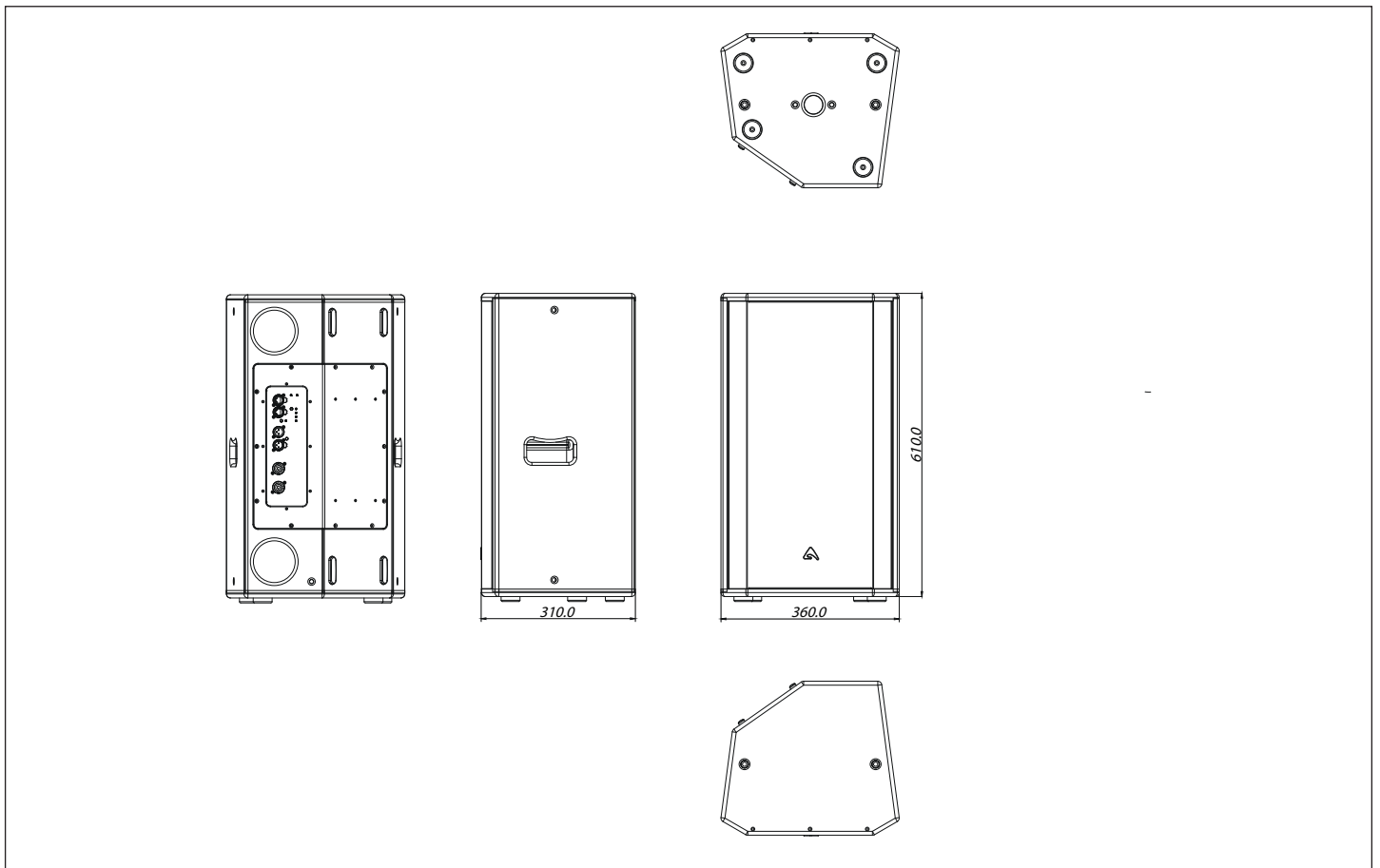

ED120A frequency response

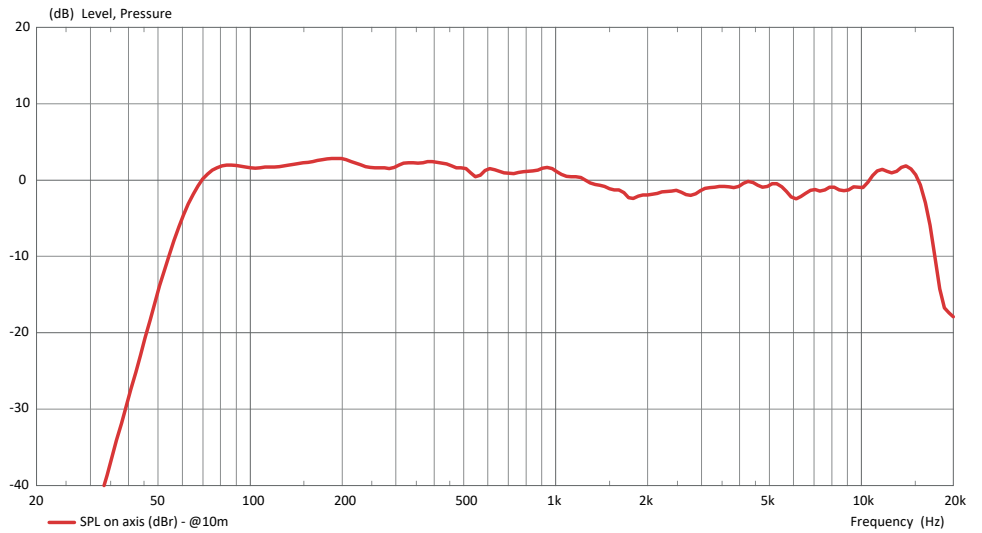

ED120A HORIZONTAL directivity map

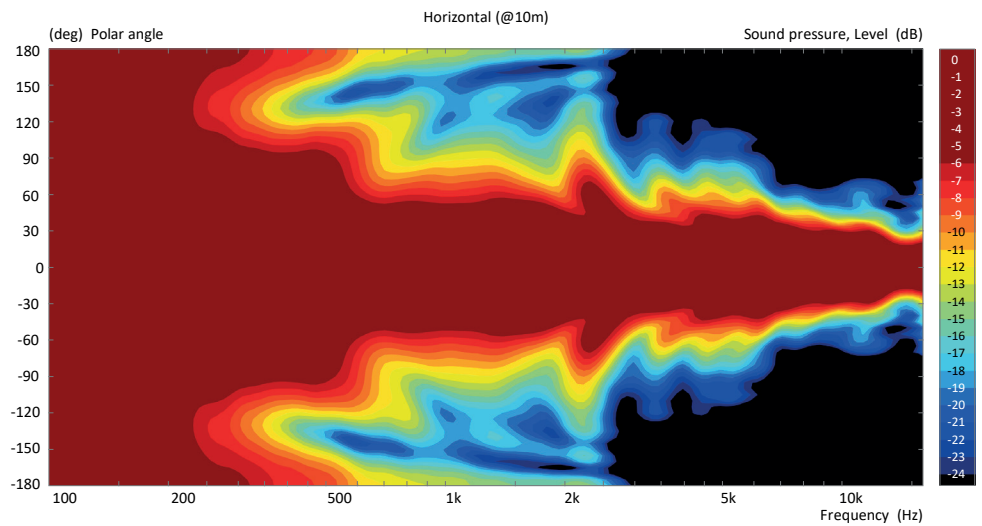

ED120A VERTICAL directivity map

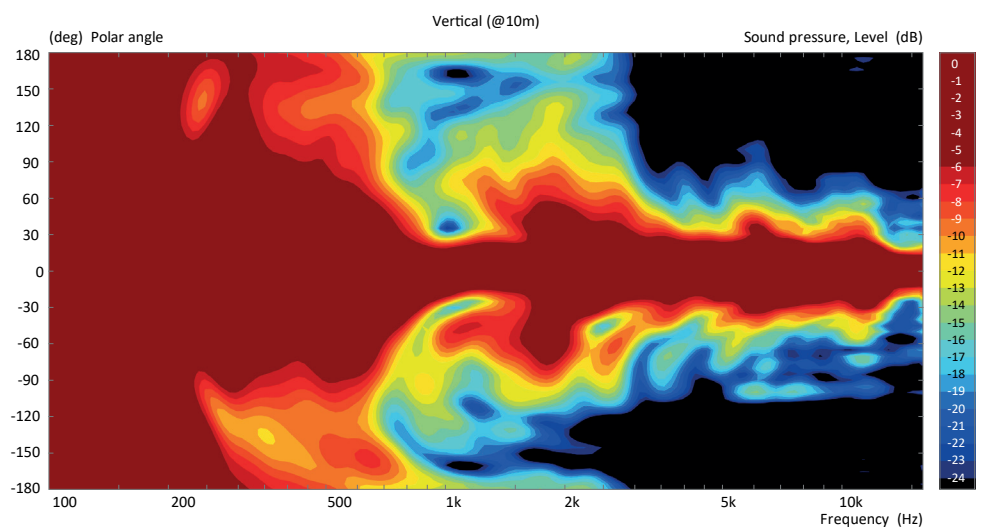

ED120A HF HORIZONTAL polar diagram

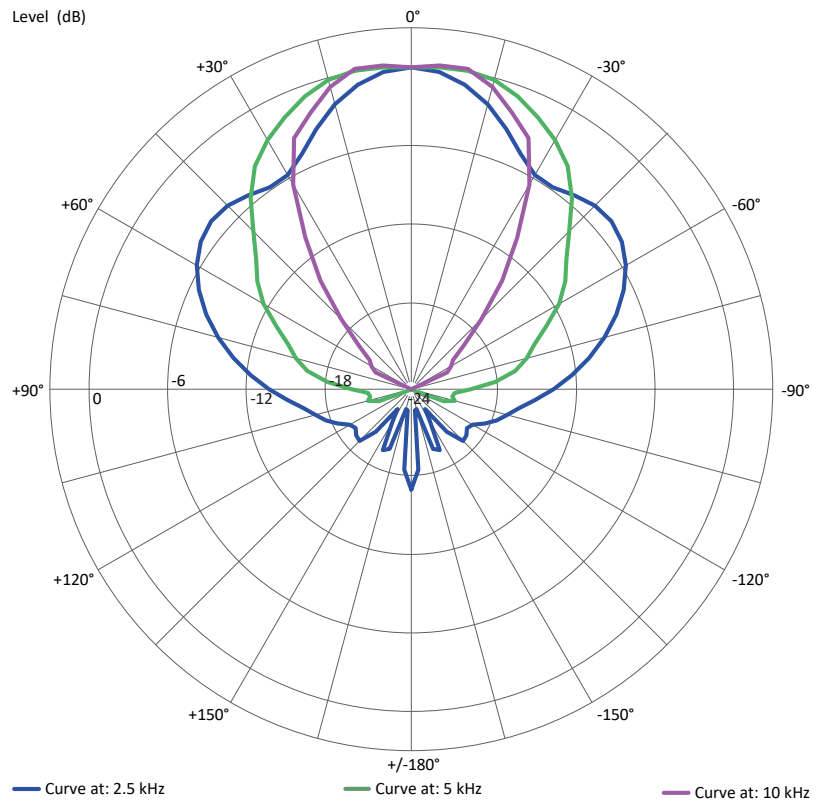

ED120A HF VERTICAL polar diagram

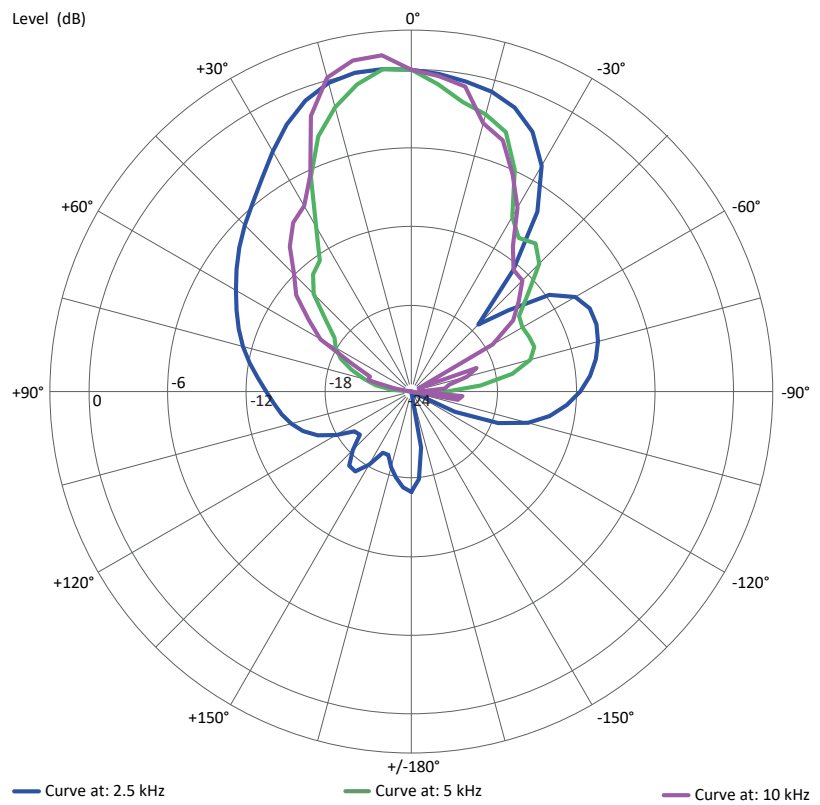

ED120A LF HORIZONTAL polar diagram

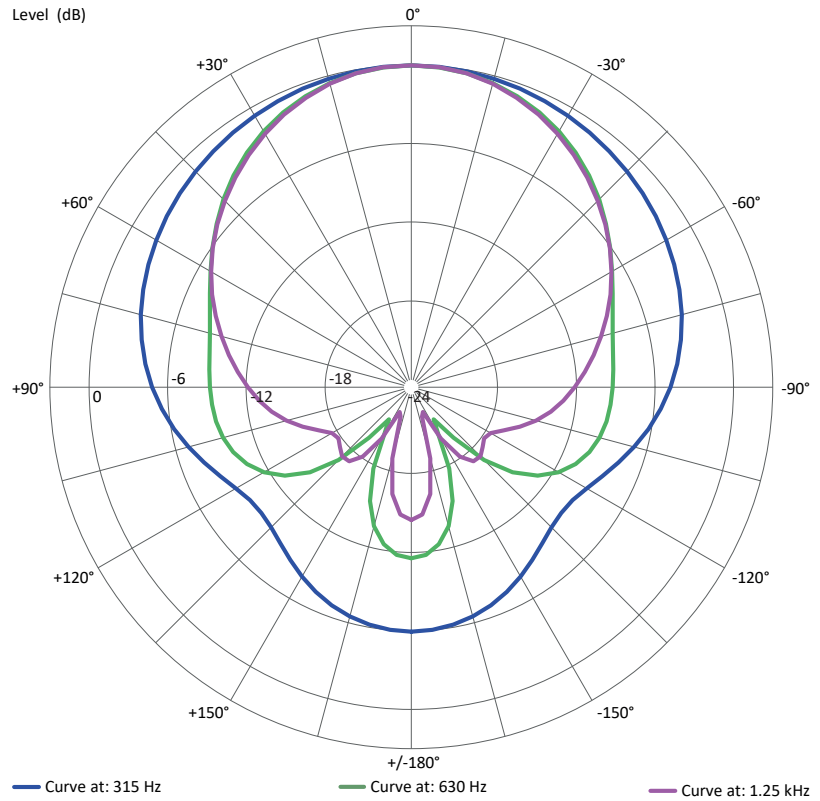

ED120A LF VERTICAL polar diagram

